

System: Laufschiene eingetuet, für 1 Alu-Rahmentüre bis 25 kg. Design Alu 40/22 mm – Forslide

System: Top running track groove mounted, for 1 aluminium framed glass door up to 25 kg. Design aluminium 40/22 mm – Forslide

Sistema: Binario di scorrimento incastrato, per 1 anta con telaio in alluminio fino a 25 kg. Design alluminio 40/22 mm – Forslide

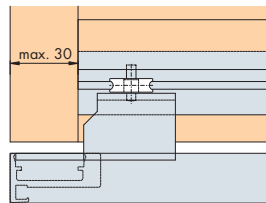
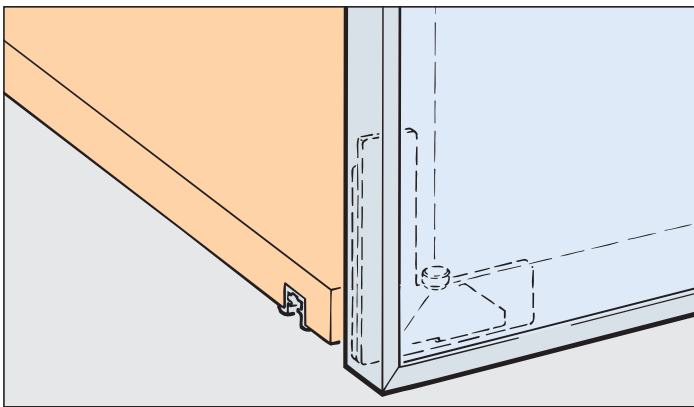

Einbaubeispiele / Mounting examples / Esempi di montaggio

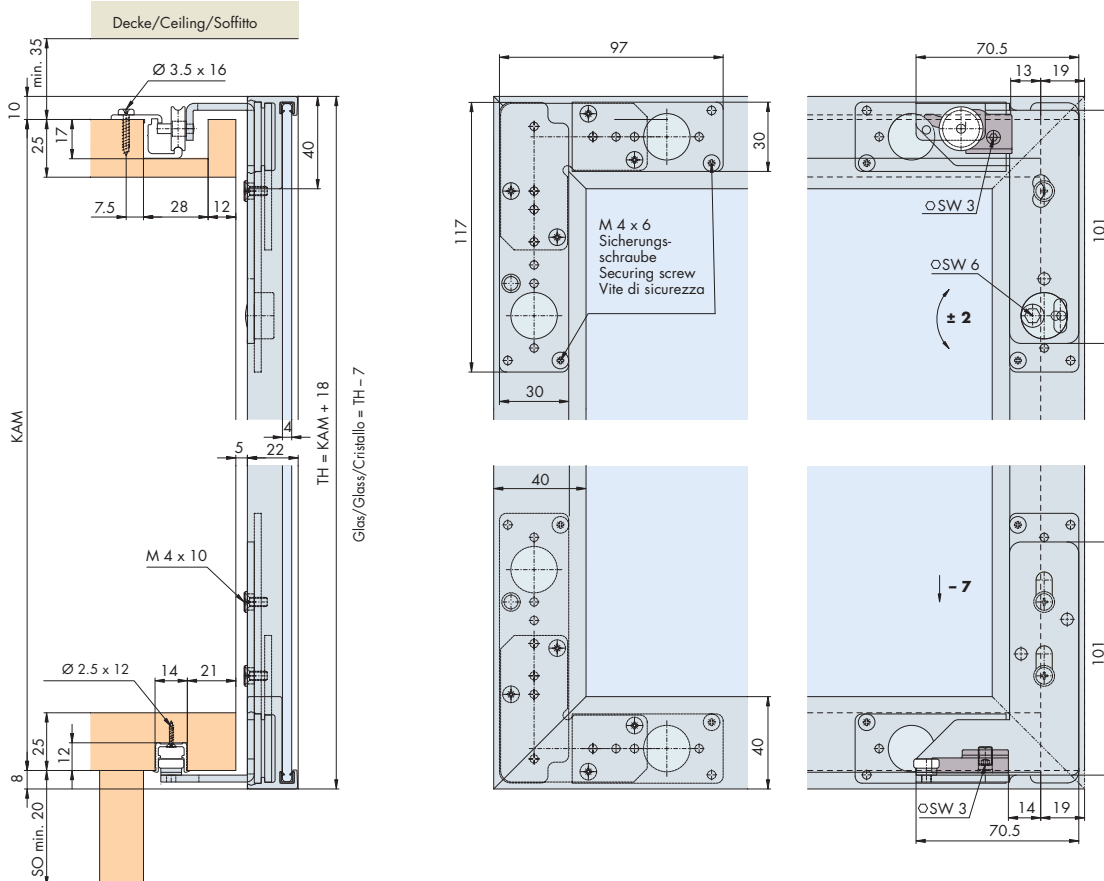

Glasempfehlung / Glass recommendation / Suggerimento per il cristallo  77

Einbaubeispiel Zwischenstopper

Mounting example intermediate stop

Esempio di montaggio fermo intermedio

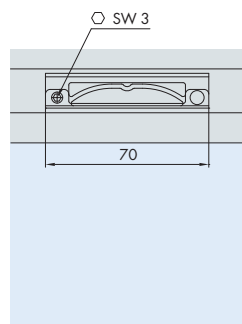

Garnituren / Sets / Guarniture

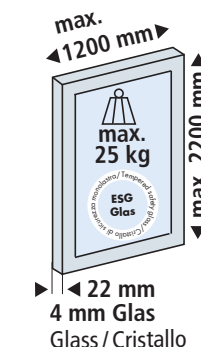

Türgewichte
Door weights
Pesi ante 78

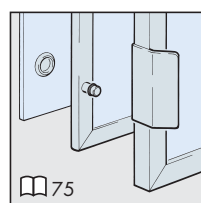

1 Türe Door Anta	No. 056.3081.171	
	2x	2x
	4x	1x 1x
	2x	

Zubehör / Accessories / Accessori

Einfachlaufschiene, Alu eloxiert, gelocht

Single top running track, aluminium anodized, pre-drilled
Binario di scorrimento semplice, alluminio anodizzato, forato

Gr./Size

Art. No./Cat. No.

2500 mm	056.3041.250
3500 mm	056.3041.350
6000 mm	056.3041.600

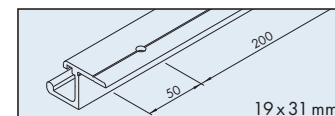

Einfachführungsschiene, Alu, gelocht

Single guide track, aluminium, pre-drilled
Binario di guida semplice, alluminio, forato

2500 mm	056.3079.250
3500 mm	056.3079.350
6000 mm	056.3079.600

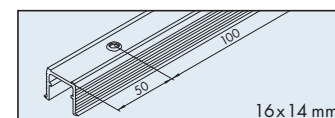

Glas-Rahmenprofil, Alu eloxiert

Glass frame profile, aluminium anodized
Profilo di telaio per cristallo, alluminio anodizzato

2500 mm	056.3070.250
3500 mm	056.3070.350
6000 mm	056.3070.600

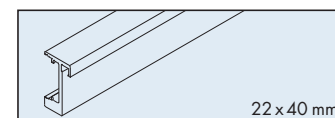

Dichtungsprofil, Kunststoff grau, für Glas-Rahmenprofil

Sealing profile, plastic grey, for glass frame profile
Profilo di guarnizione, plastica grigia, per profilo di telaio per cristallo

2500 mm	040.3061.250
---------	--------------

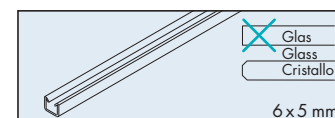

Zwischenstopper, Kunststoff grau

Intermediate stop, plastic grey
Fermo intermedio, plastica grigia

1x	056.3049.071
----	--------------

