

**System: Clip-Schiene 22/30 mm,
für 1 Holztüre bis 16 kg.
Design Inslide**

System: Clip on track 22/30 mm,
for 1 wooden door up to 16 kg.
Design Inslide

Sistema: Binario a clip 22/30 mm,
per 1 anta in legno fino a 16 kg.
Design Inslide

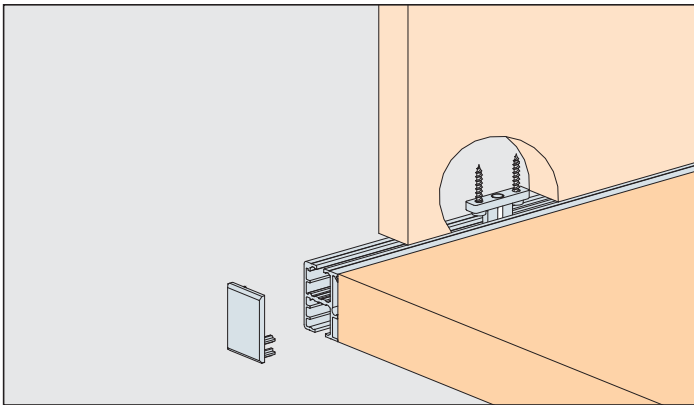

Einbaubeispiele / Mounting examples / Esempi di montaggio

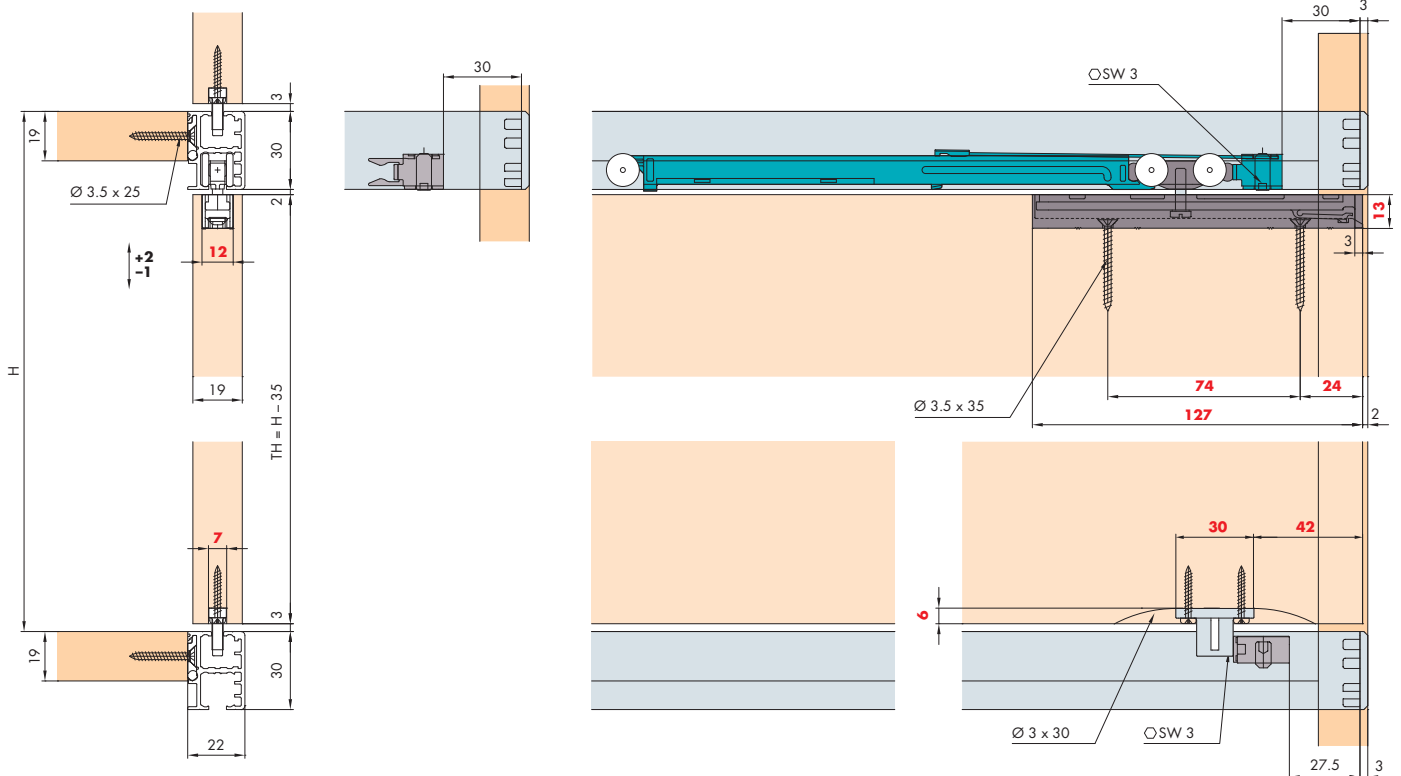

Türbearbeitung = rote Zahlen / Door treatment = red numbers / Lavorazione ante = numeri rossi

Dämpfung optional / Soft closing optional / Ammortizzatore opzionale 62/63

Variante/Option/Variante

Befestigung mit Verbindungsbolzen

Fixing with connecting bolt

Fissaggio con perni

75

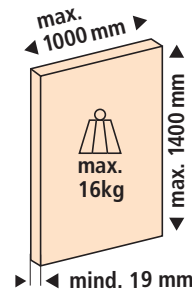
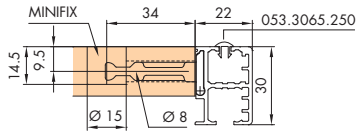

Türgewichte
Door weights
Pesi ante

78

Distanzstück 040.3129.071 für 2 Türen auf einer Ebene

Spacer 040.3129.071 for 2 doors at one level

Distanziale 040.3129.071 per 2 ante su un livello

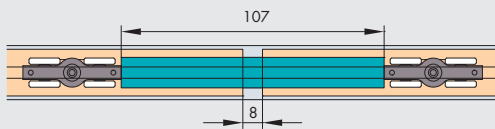

Garnituren / Sets / Guarniture

1 Türe Door Anta	No. 040.3125.071	
	2x	2x
	2x	2x
	22x	2x
	2x	1x
	4x	4x

Zubehör / Accessories / Accessori

Gr./Size

Art. No./Cat. No.

Einfachlauf-/Führungsschiene, Alu eloxiert, zum Aufclipsen

Single running track/guide track, aluminium anodized, to clip on
Binario di guida/scorrimiento semplice, allum. anod., da fissare tramite clip

2500 mm	040.3115.250
3500 mm	040.3115.350
6000 mm	040.3115.600

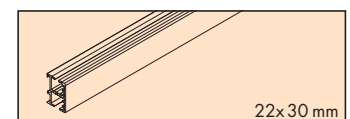

Vertikalprofil, Alu eloxiert, seitlich zum Aufclipsen

Vertical profile, aluminium anodized, to clip on laterally
Profilo verticale, alluminio anodizzato, con aggancio laterale a clip

2500 mm	040.3040.250
3500 mm	040.3040.350
6000 mm	040.3040.600

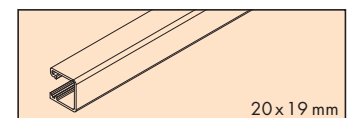

Sicherheitsclip, Druckguss grau, zu 040.3040

Safety clip, die-cast grey, for 040.3040
Clip di sicurezza, pressofusione grigia, per 040.3040

4x 040.3090.051

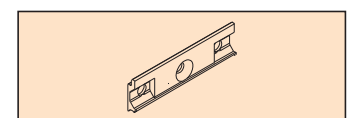

Distanzstück, Kunststoff grau, für 2 Türen auf einer Ebene

Spacer, plastic grey, for 2 doors at one level
Distanziale, plastica grigia, per 2 ante su un livello

2x 040.3129.071

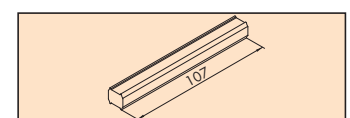

Abdeckprofil, Kunststoff grau, zu 040.3115

Cover profile, plastic grey, for 040.3115
Profilo di copertura, plastica grigia, per 040.3115

2500 mm 053.3065.250

