

**System: Laufschiene eingetutet oder aufgeschraubt, keine Nut im Boden, ohne Blende, mit Laufwerk für verdeckte Montage, für 1-2 Glastüren bis 36 kg. Design Alu-Glasfixierungsprofil 24/12 mm – Inslide**

System: Running track groove or surface mounted, no groove in the floor, without panel, with running gear for concealed fixing, for 1-2 glass doors up to 36 kg.

Design aluminium glass fixing profile 24/12 mm – Inslide

Sistema: Binario di scorrimento incastrato in scanalatura o avvitato, nessuna scanalatura nel, senza frontale, con carrello per montaggio a scomparsa, per 1-2 ante in cristallo fino a 36 kg.

Design Profilo di fissaggio cristallo alluminio 24/12 mm – Inslide

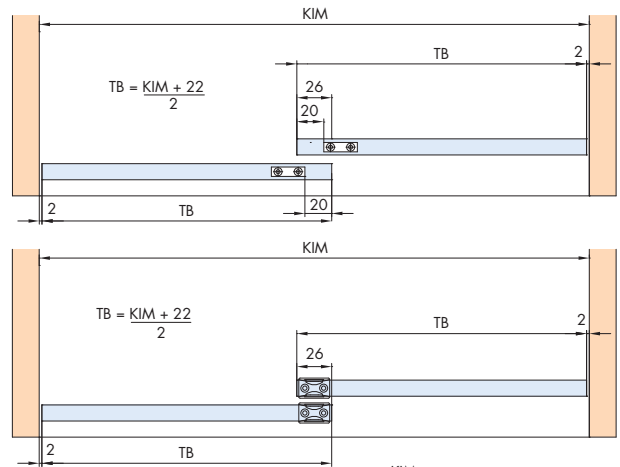
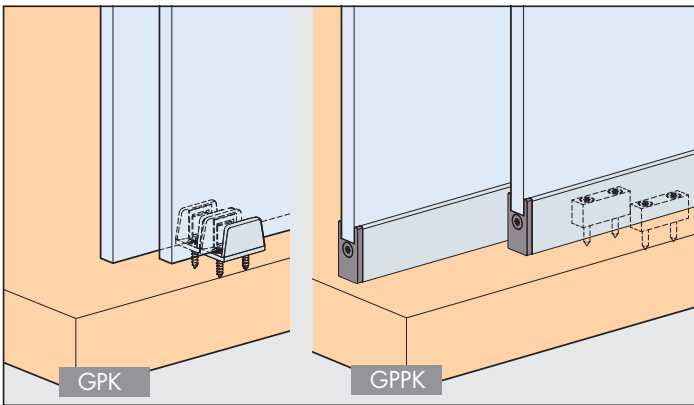

**Einbaubeispiele/Mounting examples/Esempi di montaggio**

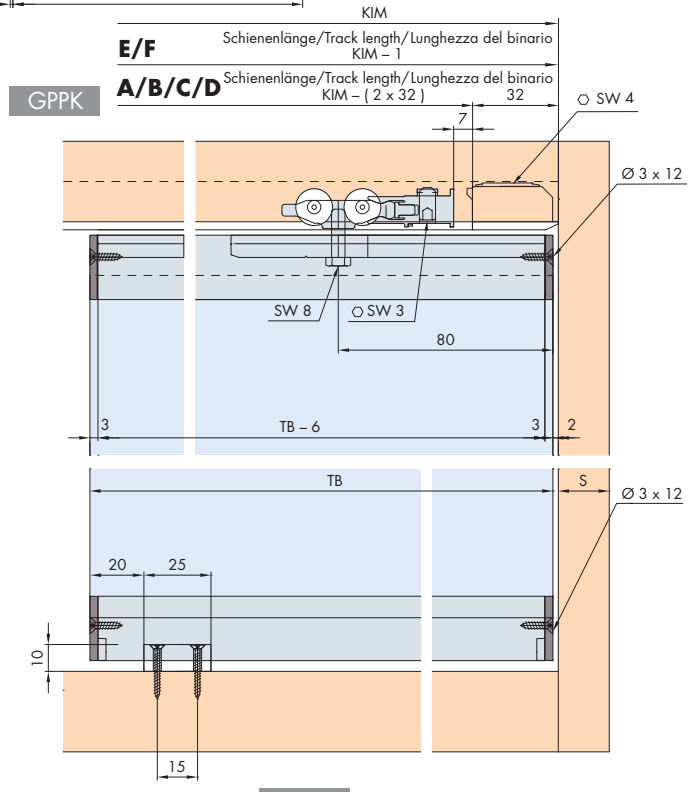
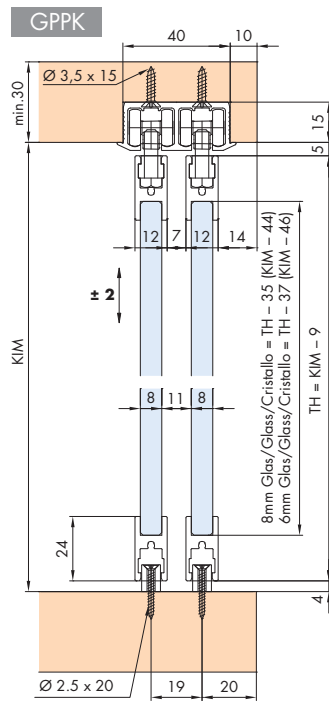
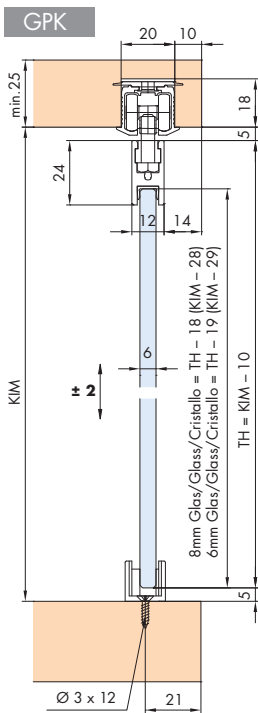

**Klebstoff-Empfehlungen für Glas: – Ceresit 3B Silikon 65**

Recommended adhesive for glass: – 3M Scotch Weld DP 105

Adesivi consigliati per cristallo:

**Dämpfung optional/Soft close optional/Ammortizzatore opzionale 68/69**

**Glasempfehlung /Glass recommendation/ Suggerimento per il cristallo 74**

**Befestigungsvarianten/Mounting options/Varianti di fissaggio**

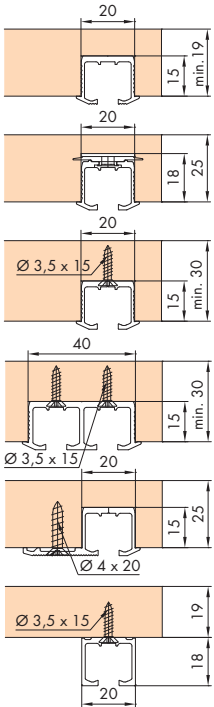

- A zum Kleben**  
for glue fixing  
da presellare o incollare
- B mit Drehriegel (nicht für Hartholz/MDF)**  
with swivel lug (not for hard wood/MDF)  
con blocco girevole (non utilizzabile su legno duro/MDF)
- C zum Schrauben**  
for screw fixing  
da avvitare
- D zum Schrauben**  
for screw fixing  
da avvitare
- E zum Schrauben**  
for screw fixing  
da avvitare
- F zum Aufschrauben**  
for surface mounting with screws  
da avvitare esternamente

**Garnituren / Sets / Guarniture**

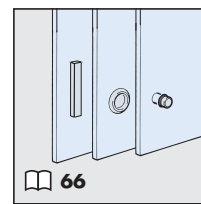
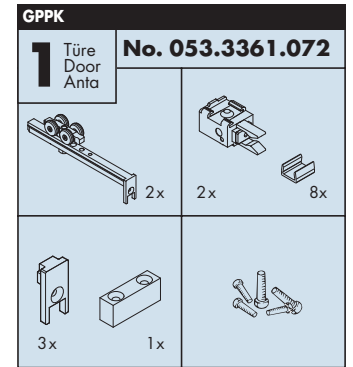
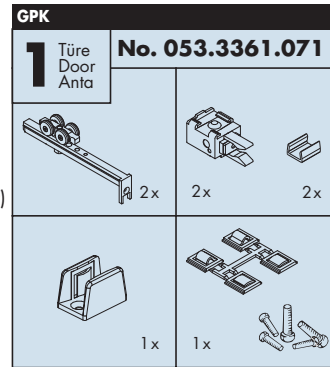

**Türgewichte**  
Door weights  
Pesi ante **69**



**Zubehör/Accessories/Accessori**

	Gr./Size	Art. No.
<b>A Einfachlaufschiene, Alu eloxiert, zum Kleben</b> Single running track, aluminium anodized, for glue fixing Binario di scorrimento semplice in alluminio, anodizzato, da incollare	2500 mm 3500 mm 6000 mm	053.3324.250 053.3324.350 053.3324.600
<b>B Einfachlaufschiene, Alu eloxiert, mit Drehriegel</b> Single running track, aluminium anodized, with swivel lug Binario di scorrimento semplice in alluminio, anodizzato, con blocco girevole <b>(nicht für Hartholz/MDF, not for hard wood/MDF, non utilizzabile su legno duro/MDF)</b>	2500 mm 3500 mm 6000 mm	053.3327.250 053.3327.350 053.3327.600
<b>C Einfachlaufschiene, Alu eloxiert, gelocht, zum Schrauben</b> Single running track, aluminium anodized, pre-drilled, for screw fixing Binario di scorrimento semplice in alluminio, anodizzato, forato, da avvitare	2500 mm 3500 mm 6000 mm	053.3325.250 053.3325.350 053.3325.600
<b>Schieneendstück zu 053.3324/3325/3327, mit Drehriegel</b> Track end piece for 053.3324/3325/3327, with swivel lug Elemento terminale binario per 053.3324/3325/3327, con blocco girevole <b>(nicht für Hartholz/MDF, not for hard wood/MDF, non utilizzabile su legno duro/MDF)</b>	2x	053.3355.051
<b>D Doppellaufschiene, Alu eloxiert, gelocht, zum Schrauben</b> Double running track, aluminium anodized, pre-drilled, for screw fixing Binario di scorrimento doppio in alluminio, anodizzato, forato, da avvitare	2500 mm 3500 mm 6000 mm	053.3342.250 053.3342.350 053.3342.600
<b>E Einfachlaufschiene, Alu eloxiert, gelocht, zum Schrauben</b> Single running track, aluminium anodized, pre-drilled, for screw fixing Binario di scorrimento semplice, in alluminio, anodizzato, forato, da avvitare	2500 mm 3500 mm 6000 mm	053.3341.250 053.3341.350 053.3341.600
<b>F Einfachlaufschiene Alu eloxiert, gelocht, zum Aufschrauben</b> Single running track aluminium anodized, pre-drilled, surface mounted Binario di scorrimento semplice, in alluminio, anodizzato, forato, da avvitare esternamente	2500 mm 3500 mm 6000 mm	053.3326.250 053.3326.350 053.3326.600
<b>Glasfixierungsprofil Alu, eloxiert</b> Glass fixing profile aluminium, anodized Profilo per il fissaggio del cristallo, alluminio, anodizzato	2500 mm 3500 mm 6000 mm	053.3072.250 053.3072.350 053.3072.600

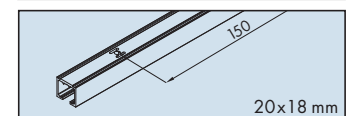
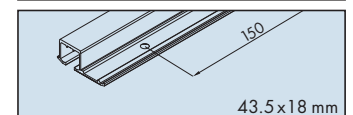
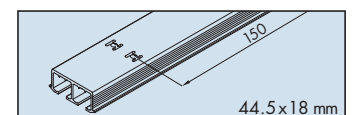
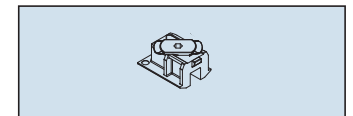
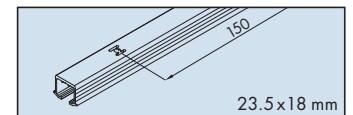
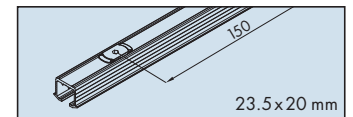
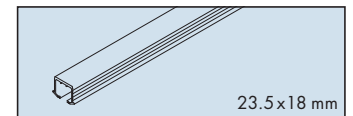

**Schliess-System/Locking system/Sistemi di chiusura:** 56/57

**Sonderzubehör und Schieneendstücke/Special accessories and track end pieces/**

Accessori speciali e elementos terminale binario: 64-66