

**System: Laufschiene aufgeschraubt, für 2-3 Holztüren, bis 60 kg. Design Inslide**

System: Running track screwed on, for 2-3 wooden doors up to 60 kg. Design Inslide

Sistema: Binario di scorrimento avvitato, per 2-3 ante in legno fino a 60 kg. Design Inslide

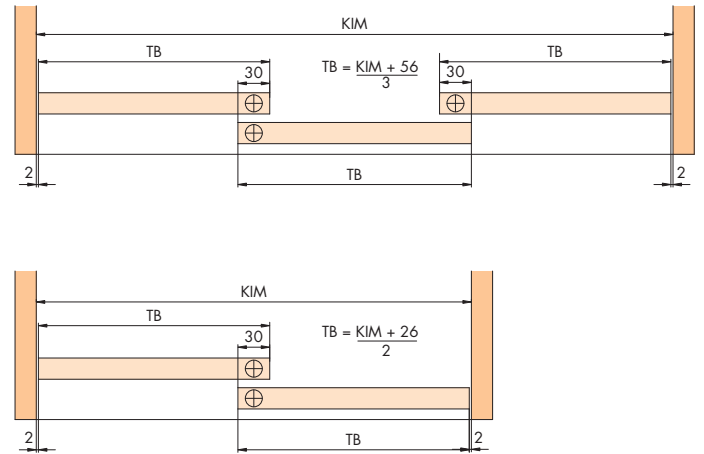
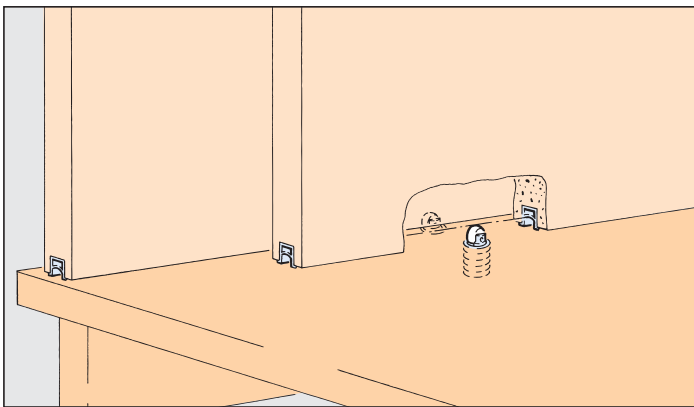

**Einbaubeispiele / Mounting examples / Esempi di montaggio**

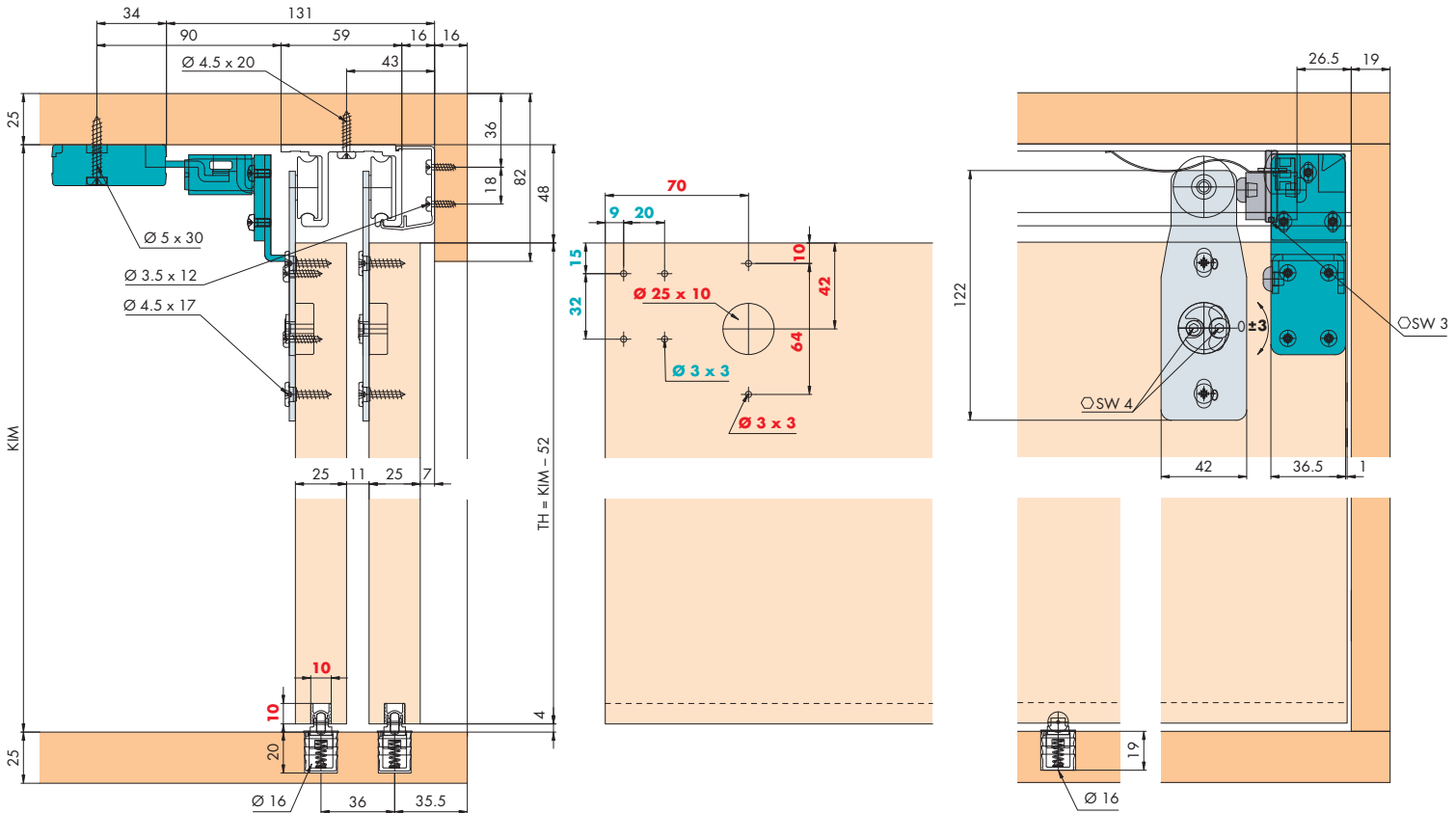

Dämpfung optional / Soft closing optional / Ammortizzatore opzionale 56/57

Türbearbeitung = rote Zahlen / Door treatment = red numbers / Lavorazione ante = numeri rossi

**Zwischenstopper für 3 Türen**

Intermediate stop for 3 doors

Fermo intermedio per 3 ante

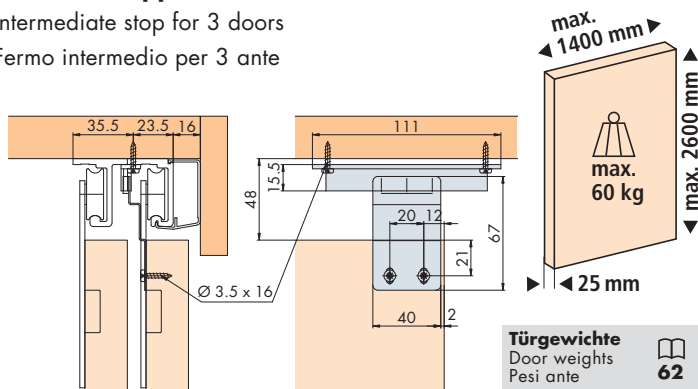

**Türgewichte**  
Door weights  
Pesi ante **62**

**Garnituren / Sets / Guarniture**

2 Türen Doors Ante	No. 055.3093.071	
	4x	4x
	2x	8x
	2x	1x

3 Türen Doors Ante	No. 055.3093.072	
	6x	4x
	3x	12x
	3x	3x

**Zubehör / Accessories / Accessori**

**Einfachlaufschiene, Alu, gelocht**

Single running track, aluminium, pre-drilled  
Binario di scorrimento semplice, alluminio, forato

Gr./Size	Art. No.
2500 mm	055.3001.250
3500 mm	055.3001.350
6000 mm	055.3001.600

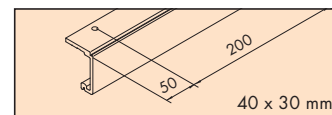

**Doppellaufschiene, Alu, gelocht**

Double running track, aluminium, pre-drilled  
Binario di scorrimento doppio, alluminio, forato

2500 mm	055.3000.250
3500 mm	055.3000.350
6000 mm	055.3000.600

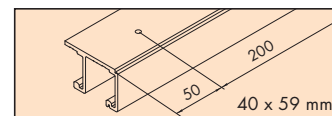

**Führungsschiene, Alu, zum Kleben**

Guide track, aluminium, for glue fixing  
Binario di scorrimento, alluminio, da incollare

2500 mm	053.3074.250
3500 mm	053.3074.350
6000 mm	053.3074.600

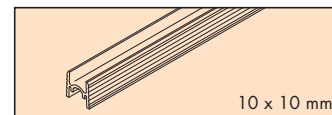

**Clip-Teil, Alu, gelocht, für Holzblende (alle 700–800 mm)**

Clip component, aluminium, pre-drilled, for wooden panel (every 700–800 mm)  
Clip in alluminio, forato, per frontale in legno (ogni 700–800 mm)

055.3084.001

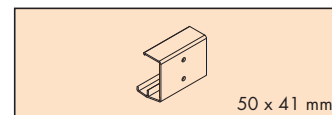

**Zwischenstopper**

Intermediate stop  
Fermo intermedio

056.3035.071

