

System: Laufschiene eingetutet oder aufgeschraubt, Glasklemmschuh mit Laufwerk und Blende, für 1-2 Glasuren bis 36 kg. Design Alu-Blende für Klemmschuh

System: Running track groove or surface mounted, glass clamping shoe with running gear and panel, for 1-2 glass doors up to 36 kg. Design aluminium panel for clamping shoe

Sistema: Binario di scorrimento incastrato in scanalatura o avvitato, pattino di serraggio per cristallo con carello e frontale, per 1 o 2 ante in cristallo fino a 36 kg. Frontale design in alluminio per pattino di serraggio

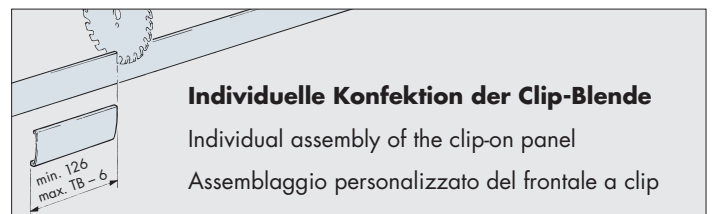
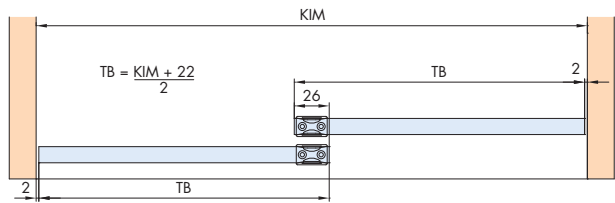
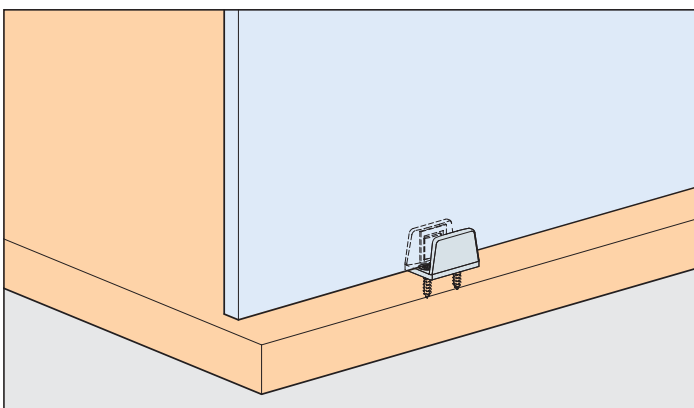

Individuelle Konfektion der Clip-Blende
Individual assembly of the clip-on panel
Assemblaggio personalizzato del frontale a clip

Einbaubeispiele/Mounting examples/Esempi di montaggio

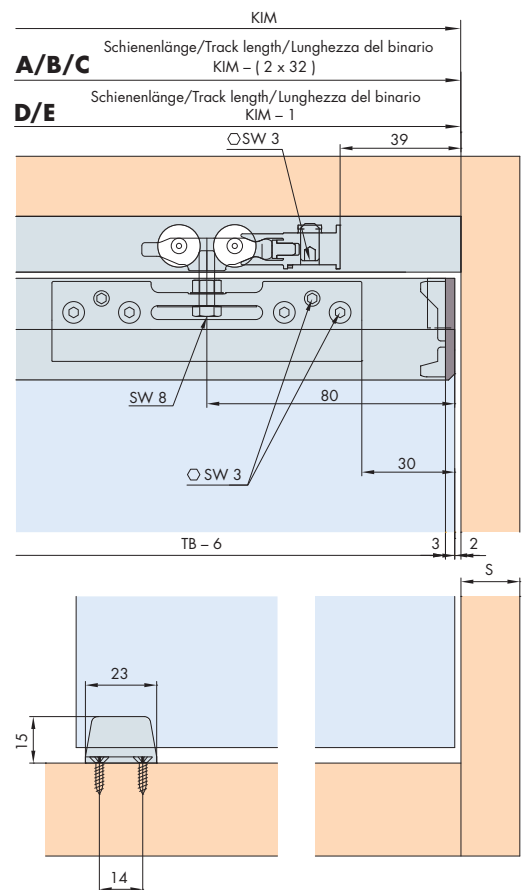
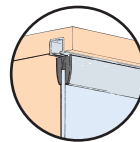
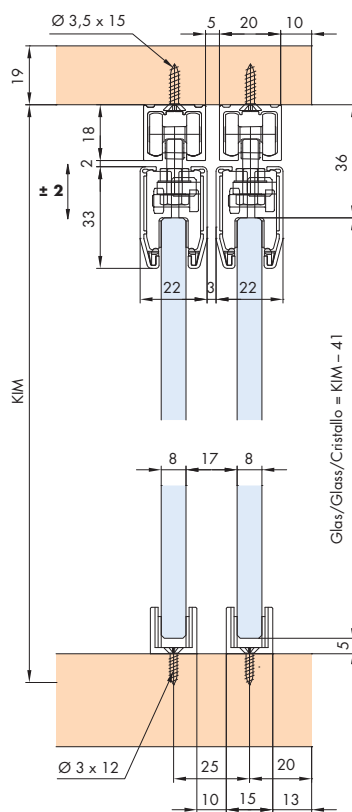
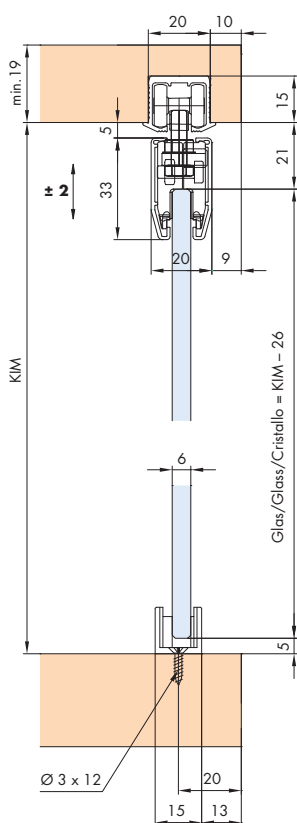

Einbaubeispiele mit Glasbearbeitung

Mounting examples with glass processing

Esempi di montaggio con lavorazione del cristallo

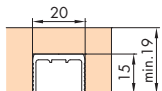
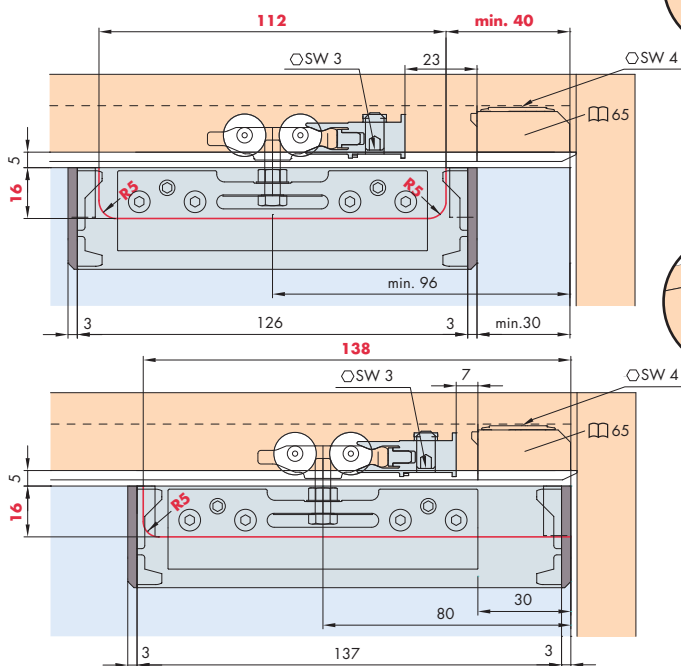

A zum Kleben
for glue fixing
da presellare o incollare

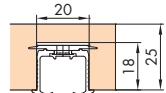

B mit Drehriegel (nicht für Hartholz/MDF)
with swivel lug (not for hard wood/MDF)
con blocco girevole
(non utilizzabile su legno duro/MDF)

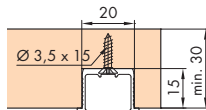

C zum Schrauben
for screw fixing
da avvitare

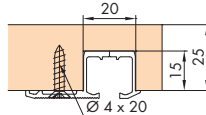

D zum Schrauben
for screw fixing
da avvitare

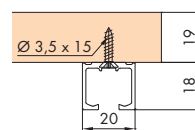

E zum Aufschrauben
for surface mounting
with screws
da avvitare esternamente

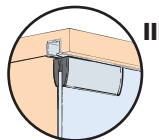
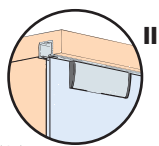

Türgewichte
Door weights
Pesi ante **69**



Garnituren / Sets / Guarniture



Zubehör / Accessories / Accessori

A Einfachlaufschiene, Alu eloxiert, zum Kleben

Single running track, aluminium anodized, for glue fixing
Binario di scorrimento semplice in alluminio, anodizzato, da incollare

Gr./Size

Art. No.

2500 mm 053.3324.250
3500 mm 053.3324.350
6000 mm 053.3324.600

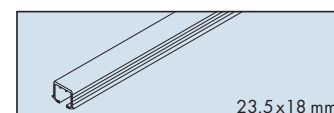

B Einfachlaufschiene, Alu eloxiert, mit Drehriegel

Single running track, aluminium anodized, with swivel lug
Binario di scorrimento semplice in alluminio, anodizzato, con blocco girevole
(nicht für Hartholz/MDF, not for hard wood/MDF, non utilizzabile su legno duro/MDF)

2500 mm 053.3327.250
3500 mm 053.3327.350
6000 mm 053.3327.600

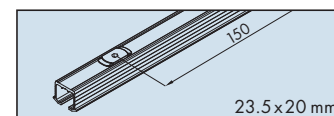

C Einfachlaufschiene, Alu eloxiert, gelocht, zum Schrauben

Single running track, aluminium anodized, pre-drilled, for screw fixing
Binario di scorrimento semplice in alluminio, anodizzato, forato, da avvitare

2500 mm 053.3325.250
3500 mm 053.3325.350
6000 mm 053.3325.600

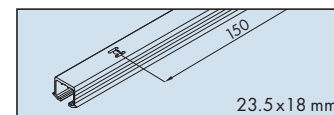

D Einfachlaufschiene, Alu eloxiert, gelocht, zum Schrauben

Single running track, aluminium anodized, pre-drilled, for screw fixing
Binario di scorrimento semplice, in alluminio, anodizzato, forato, da avvitare

2500 mm 053.3341.250
3500 mm 053.3341.350
6000 mm 053.3341.600

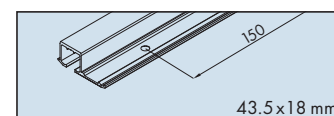

E Einfachlaufschiene Alu eloxiert, gelocht, zum Aufschrauben

Single running track aluminium anodized, pre-drilled, surface mounted
Binario di scorrimento semplice, in alluminio, anodizzato, forato,
da avvitare esternamente

2500 mm 053.3326.250
3500 mm 053.3326.350
6000 mm 053.3326.600

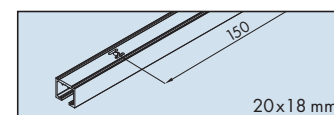

Clip-Blende zu Klemmschuh, Alu eloxiert

Clip-on panel for clamping shoe, aluminium anodized
Frontale a clip per pattino di serraggio, alluminio, anodizzato

2500 mm 053.3168.250
3500 mm 053.3168.350
6000 mm 053.3168.600

